

M23 FEMALE 0° 6POLE

PVC (4G1,5+(2x1,5)C)C 26m

Power cable with brake wires for SINAMICS S120 and motors with M23 connection and holding brake

Female straight

M23, 6-pole

without cable sleeves

Further cable lengths on request.

Plastic housings with good resistance against chemicals and oils.

The resistance to aggressive media should be individually tested for your application. Further details on request.

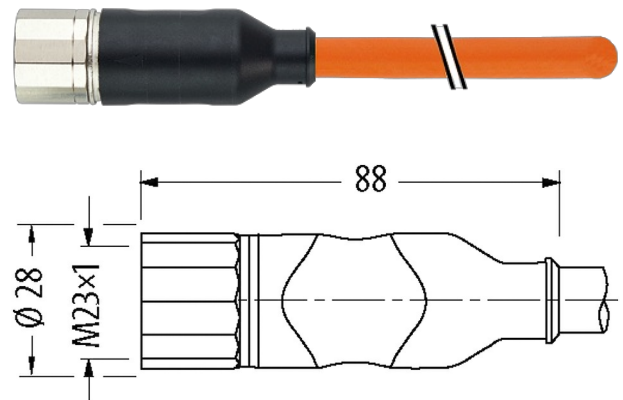
[Link to Product](#)**Illustration**

Product may differ from Image

Form

Form PS501

General data

Pollution Degree	3
Temperature range	-25...+85 °C, depending on cable quality

Cables

Cable number	861
No./diameter of wires	(4G1.5 + (2x 1.5)C)-C
Wire isolation	TPM (bk num, gnye)
C-track properties	0.1 Mio.
Torsion stress	±30°/m
Jacket Color	orange
Material (jacket)	PVC (UL/CSA) (=MC500)
Specification	6FX5008-1BA11
Outer Ø	10.4 mm ±5%
Bend radius (fixed)	5x outer Ø
Bend radius (moving)	18x outer Ø
Temperature range (fixed)	-40...+80 °C
Temperature range (mobile)	-20...+60 °C
Shield	yes
Approval (cable)	UL (AWM-Style 2570/10492), CSA
Diameter (core)	4x 2.5 + 2x 1.5 mm ²

Technical Data

Operating voltage	600 V AC/DC (PIN 1/2/3/6); 250 V AC/DC (PIN 4/5)
Rated surge voltage	4 kV (PIN 1/2/3/6); 2 kV (PIN 4/5)
Operating current per contact	Power cores: 12 A (1.5 mm ²), 15 A (2.5 mm ²); brake cores: 5 A (1.5 mm ²)
Material group	IEC 60664-1, category I
Locking of ports	Screw thread (M23×1 mm) recommended torque 2.0 Nm, self-securing
Compression gland	M23 (SW27)
Protection	IP65 and IP67 when plugged and screwed down (EN 60529)
Locking material	Brass, nickel plated
Material	PUR
suitable for corrugated tube (internal Ø)	16 mm

Commercial data

country of origin	DE
customs tariff number	85444290
EAN	4048879775465
eClass	27279218
Packaging unit	1

Sketch

Female

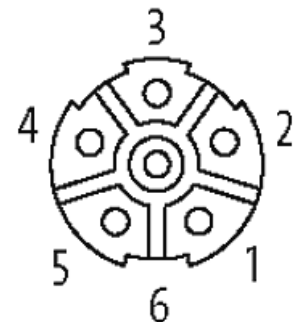

Product may differ from Image